



A FUNCTIONAL, VERSATILE, AND CUSTOMIZABLE MODULAR STORAGE SYSTEM

The Apollo Modular System provides storage and display solutions with countless configuration possibilities. With a wide range of components, the Apollo can be designed for office, retail, and residential applications.

Choose from one of our suggested combinations or build your own. Bring your dream storage unit to life by combining premium hardwood components with hand crafted finishes for an elegant storage solution.

HARDWARE

APOLLO VERTICAL POST - (0.75"W x 8"D x 90"H)

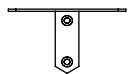

APOLLO SINGLE T BRACKET - (1.5"W x 8"D x 4"H)
*2 pcs per component

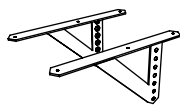

APOLLO DESK BRACKET HARDWARE - LEFT & RIGHT BRACKETS (7.5H x 15.5D)
*1 set for component 18" deep and over

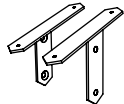

APOLLO ANGLED T BRACKET (SHOE SHELF) - LEFT AND RIGHT BRACKETS (6H x 7.5D)
*1 set per shoerack



APOLLO HANGER BAR IRON FOR 18"/29"/36"/48" SHELVES
*Used for Shoe Rack / Shelf Assembly

14.5"

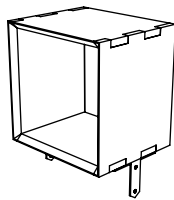

CIAO OPEN BOX - (14.5"W x 12"D x 14.5"H)

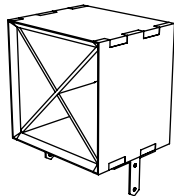

CIAO OPEN BOX FOR WINE BOTTLE STORAGE - (14.5"W x 12"D x 14.5"H)

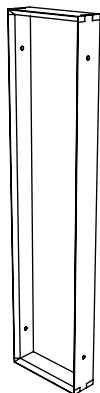

CIAO MIRROR WITH 3 IN LEDGE - (14.5"W x 4.5"D x 60"H)

18"

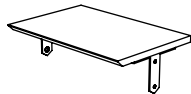

CIAO SHELF - (18"W x 12"D x 3/4"H)



CIAO SHELF WITH HANGER BAR - (18"W x 12"D x 3.5"H)

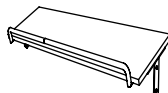

CIAO SHOE SHELF - (18"W x 13"D x 8"H)

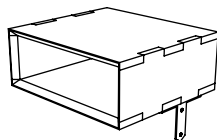

CIAO OPEN BOX - (18"W x 16"D x 7"H)

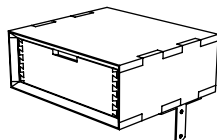

CIAO BOX WITH 1 DRAWER - (18"W x 16"D x 7"H)

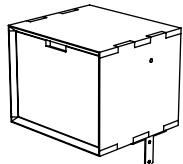

CIAO BOX FILE DRAWER - (18"W x 16"D x 14.5"H)
*Letter Size Files Orientation Front to Back.

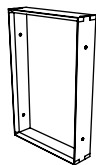

CIAO MIRROR WITH 3 IN LEDGE - (18"W x 4.5"D x 31.5"H)

29"

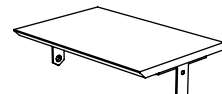

CIAO SHELF - (29"W x 12"D x 3/4"H)



CIAO SHELF WITH HANGER BAR - (29"W x 12"D x 3.5"H)

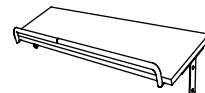

CIAO SHOE SHELF - (29"W x 13"D x 8"H)

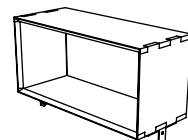

CIAO OPEN BOX - (29"W x 12"D x 14.5"H)

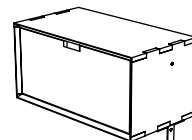

CIAO BOX WITH DROP DOWN DOOR - (29"W x 16"D x 14.5"H)

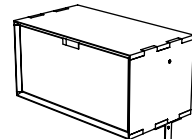

CIAO BOX FILE DRAWER - (29"W x 16"D x 14.5"H)
*Letter Size Files Arranged Side to Side

36"

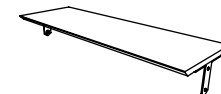

CIAO SHELF - (36"W x 12"D x 3/4"H)



CIAO SHELF WITH HANGER BAR - (36"W x 12"D x 3.5"H)



CIAO SHOE SHELF - (36"W x 13"D x 8"H)

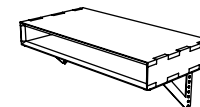

CIAO OPEN BOX - (36"W x 18"D x 5"H)

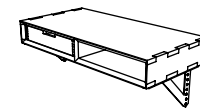

CIAO BOX WITH 1 DRAWER - (36"W x 18"D x 5"H)

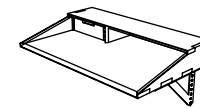

SCOUT DESK WITH PENCIL DRAWER - (36"W x 22"D x 5"H)

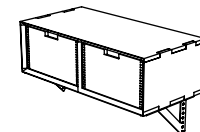

CIAO BOX DRESSER WITH TWO DRAWERS - (36"W x 18"D x 11.5"H)

48"



CIAO SHELF - (48"W x 12"D x 3/4"H)



CIAO SHELF WITH HANGER BAR - (48"W x 12"D x 3.5"H)



CIAO SHOE SHELF - (48"W x 13"D x 8"H)

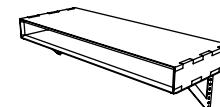

CIAO OPEN BOX - (48"W x 18"D x 5"H)

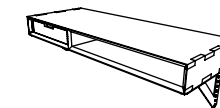

CIAO BOX WITH 1 DRAWER - (48"W x 18"D x 5"H)

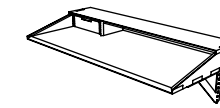

SCOUT DESK WITH PENCIL DRAWER - (48"W x 22"D x 5"H)

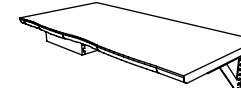

KALI OCCASIONAL TABLE TOP WITH FRONT LIVE EDGE - (48"W x 24"D x 1.6/4.6"H)
*optional with Laci Pencil Drawer

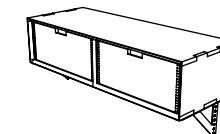

CIAO BOX DRESSER WITH TWO DRAWERS - (48"W x 18"D x 11.5"H)



FOR MORE INFORMATION PLEASE CONTACT US:

212 255 9209
sales@ftsny.com
ftsny.com

Chelsea Showroom
132 W 18th Street
New York, NY 10011

Hudson Yards Showroom
551 W 28th Street
New York, NY 10001
By Appointment Only

